

VENEZIA-160



Important information.
Read carefully.
Keep this information for further reference.

WARNING

Serious or fatal crushing injuries can occur from furniture tip-over. To prevent this furniture from tipping over it must be permanently fixed to the wall.

Fixing devices for the wall are not included since different wall materials require different types of fixing devices. Use fixing devices suitable for the wall in your home. For advice on suitable fixing systems, contact your local specialized dealer.



Wichtige Information.
Sorgfältig lesen.
Diese Information aufbewahren.

ACHTUNG

Wenn Möbelstücke umkippen, können ernste oder lebensgefährliche Verletzungen durch Einklemmen die Folge sein. Um zu verhindern, dass das Möbelstück umkippt, muss es fest an der Wand verankert werden.

Beschläge für die Wandbefestigung sind nicht beige packt, da sie von der jeweiligen Wandbeschaffenheit abhängig sind. Befestigungsbeschläge benutzen, die für die heimischen Wände geeignet sind. Bei diesbezüglichen Fragen den örtlichen Fachhandel zu Rate ziehen.



Viktig informasjon.
Les nøye.
Ta vare på denne informasjonen for fremtidig bruk.

ADVARSEL

Alvorlige ulykker kan skje som følge av møble so velter. For å forhindre at dette møbelet faller, må det festes permanent til veggen.

Festemidler for vegg er ikke inkludert fordi ulike vegger krever ulike festemidler. Bruk festemidler som passer til veggene i hjemmet ditt. Kontakt din nærmeste faghandel for råd om festemidler.

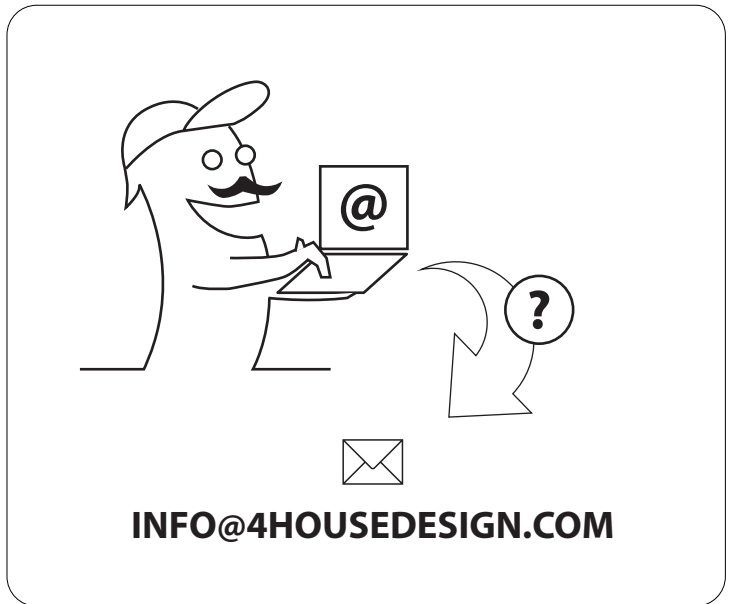
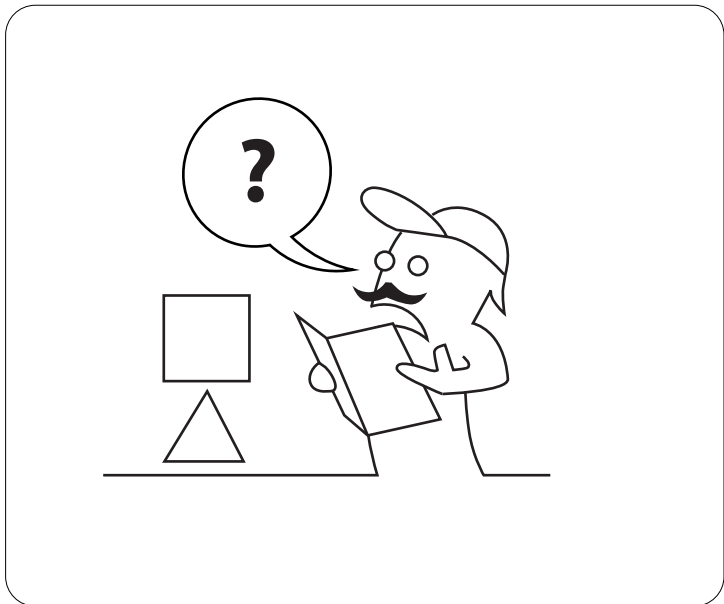
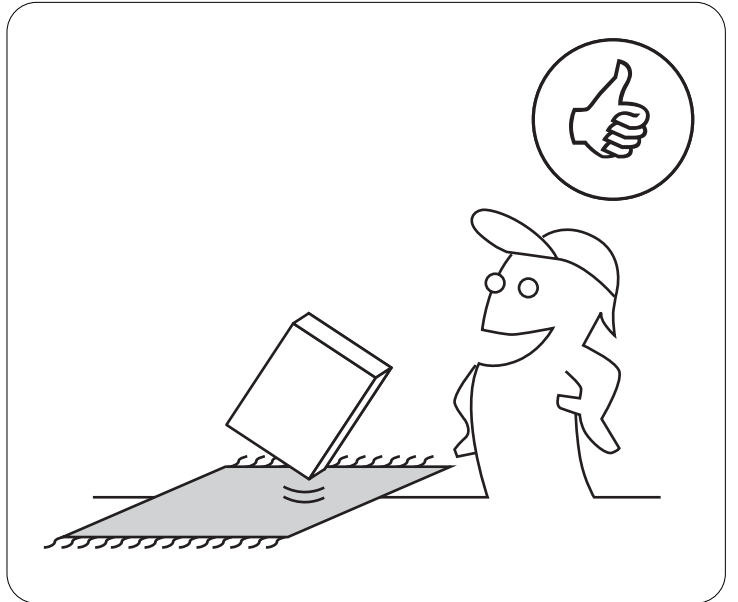
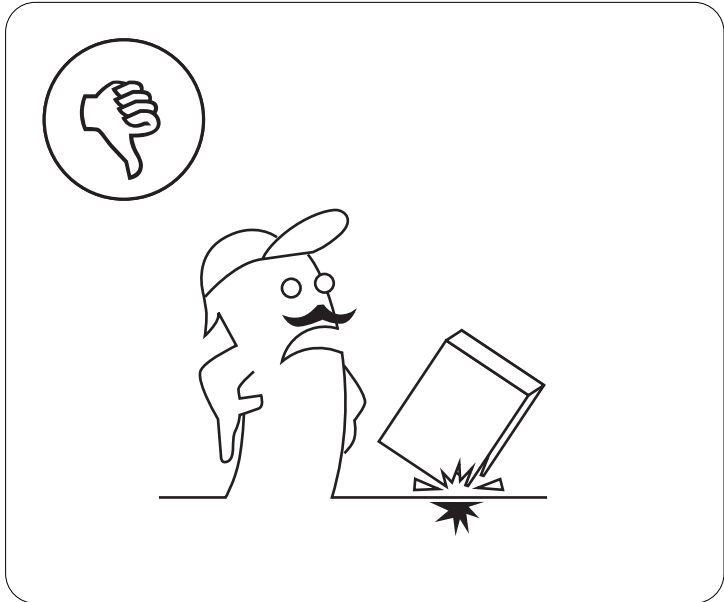
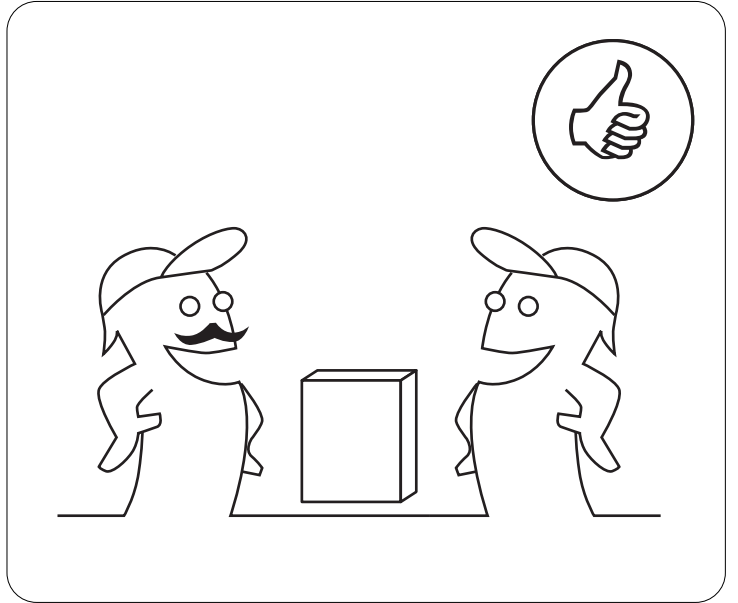
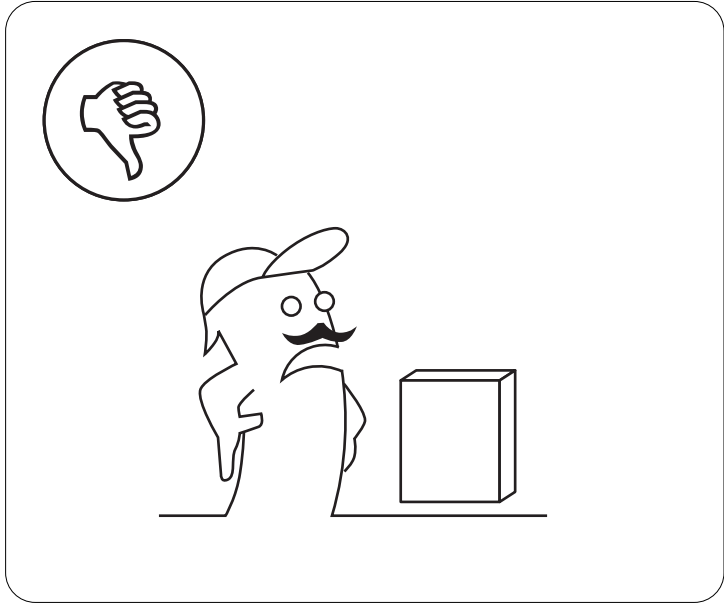

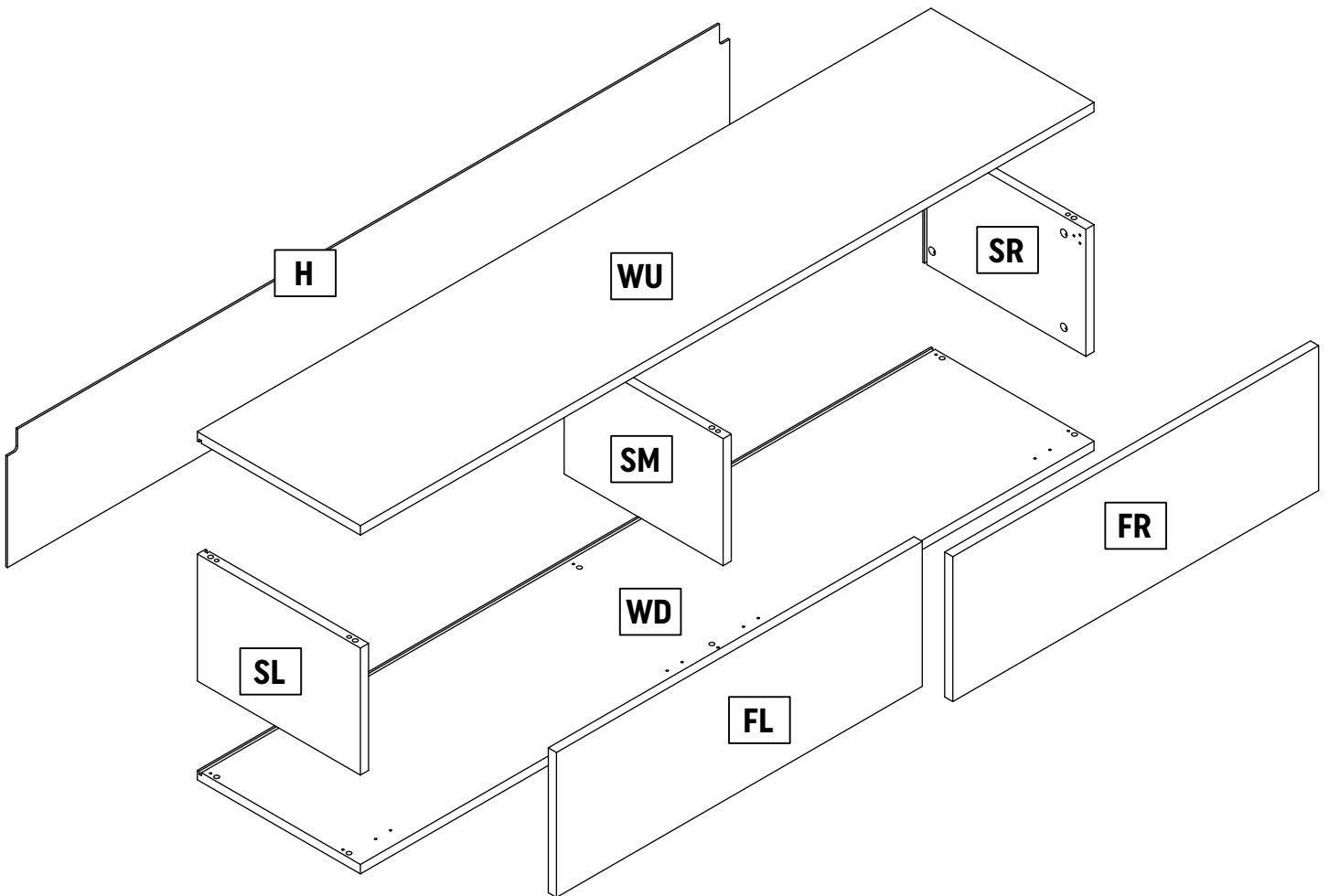
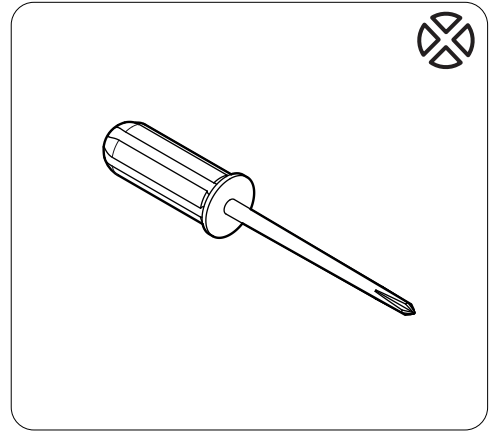
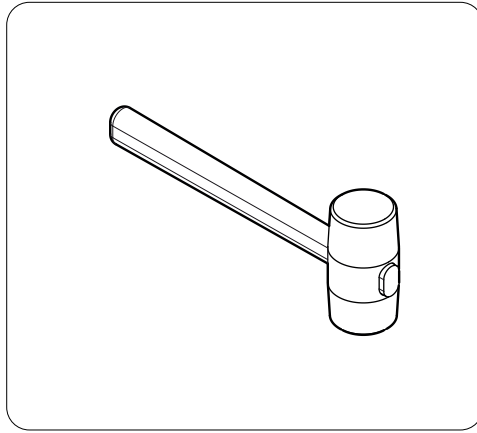
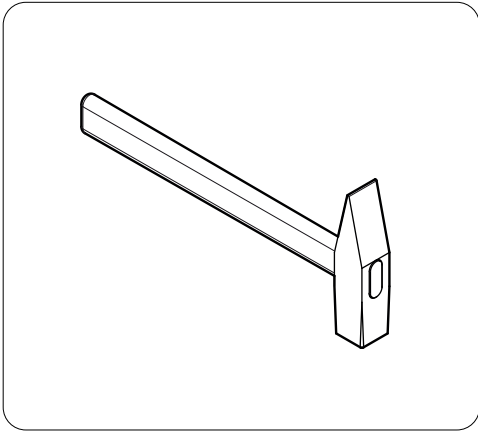



K

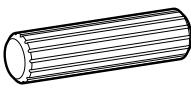

x 12

M

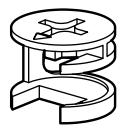

x 12

T

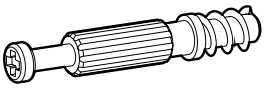

x 12

ZR

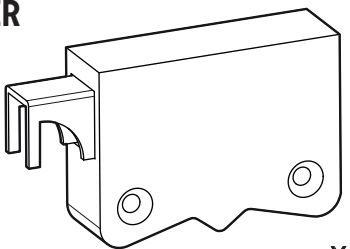

x 2

W30

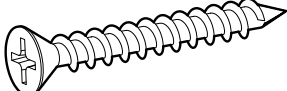

x 4 (+ x8)

W16



x 12

SB1

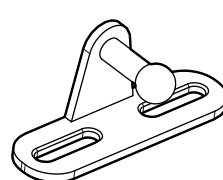

x 2

SB2

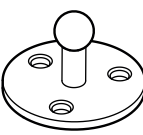

x 2

SB3

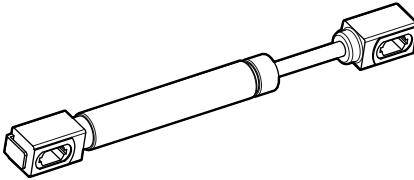

x 2

OP



x 2

HO

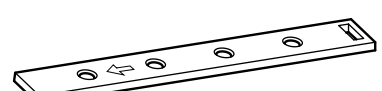

x 2

Z

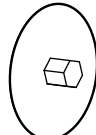

x 12

PR

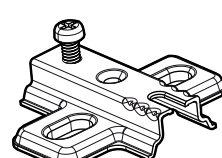

x 4

ZP

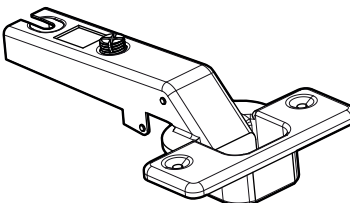

x 4

LG

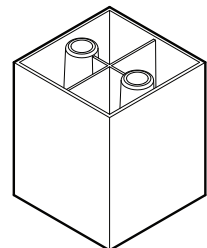

(x4)

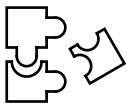

1

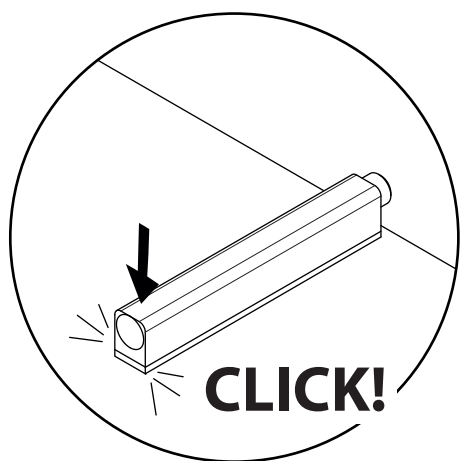
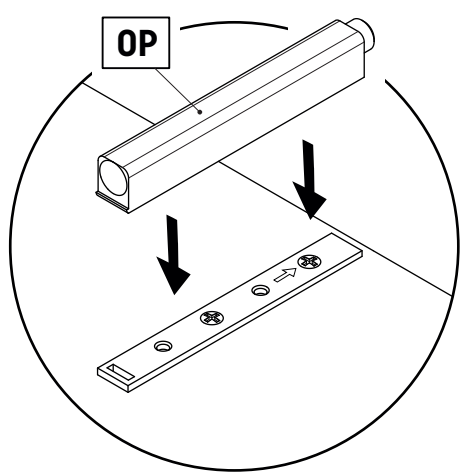
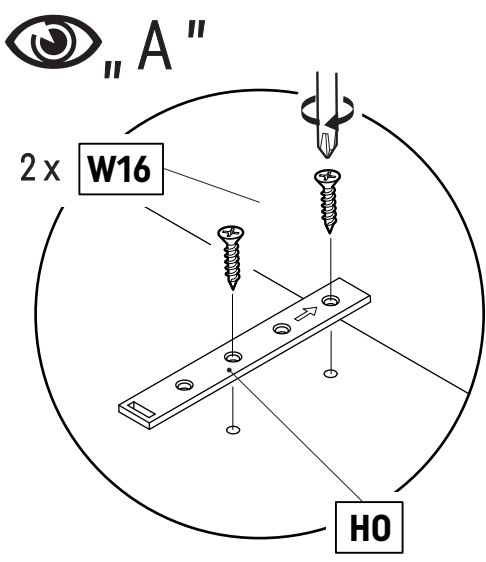
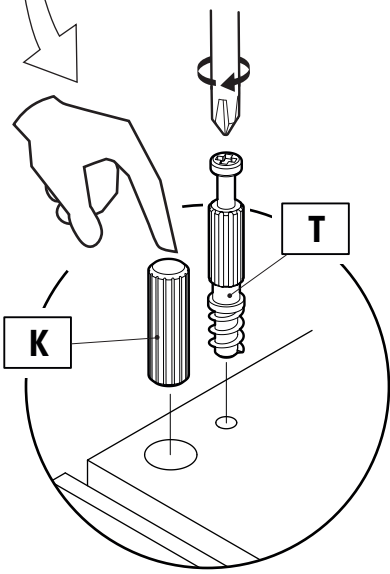
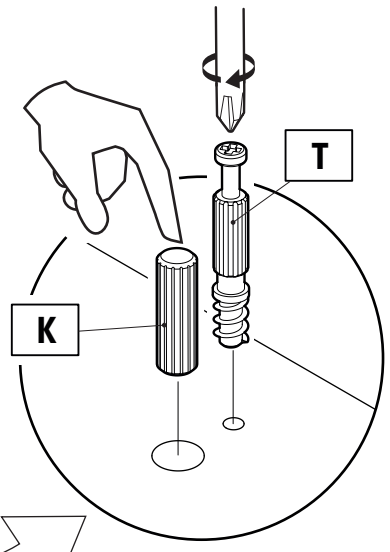
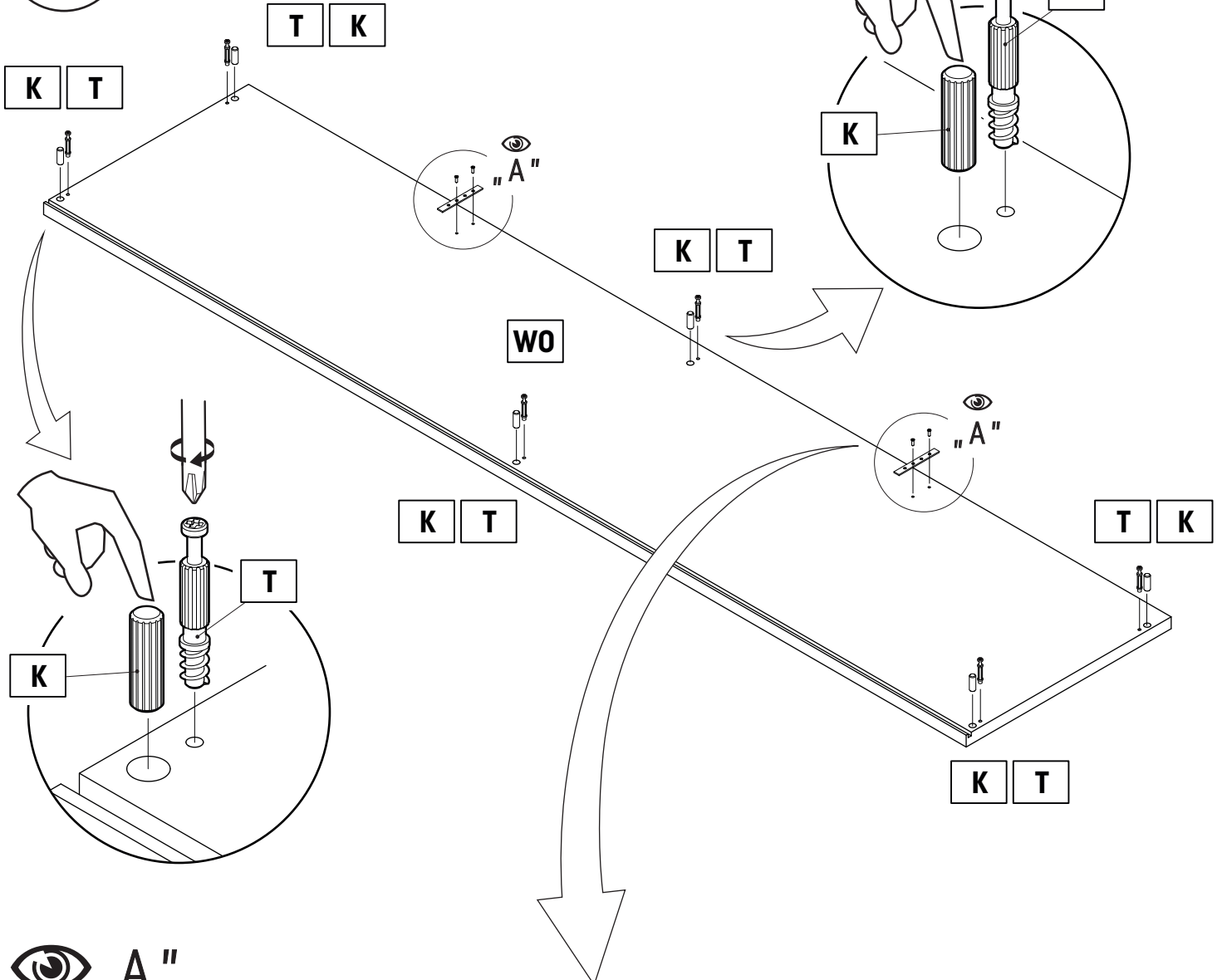

2

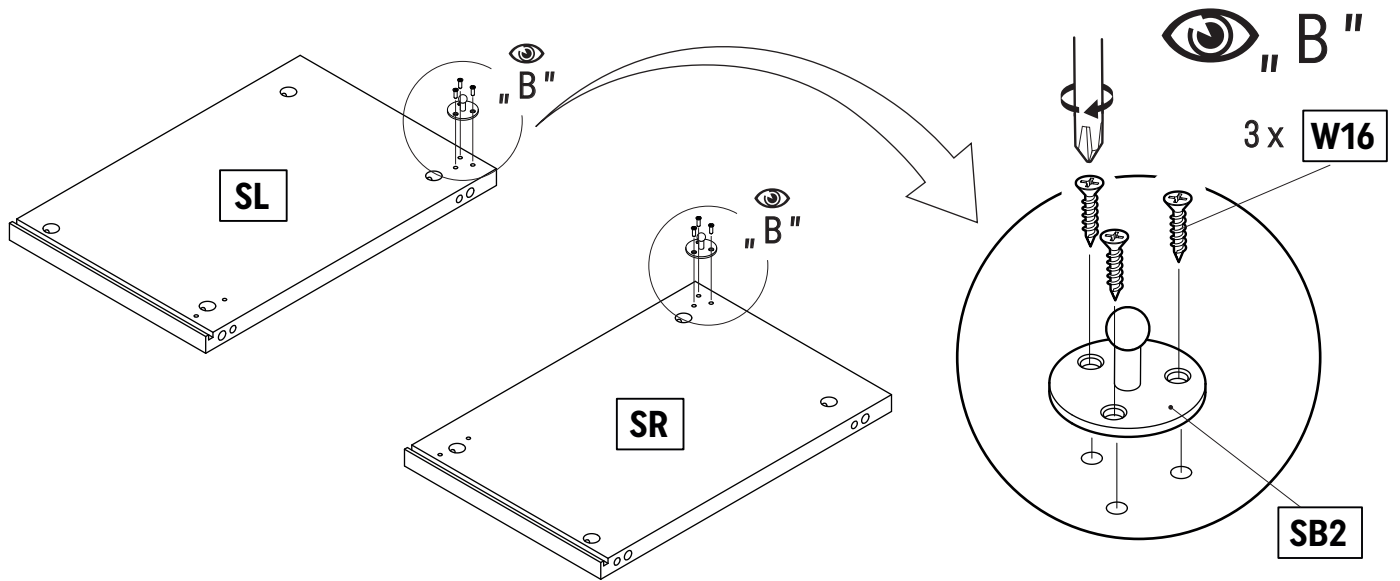

3

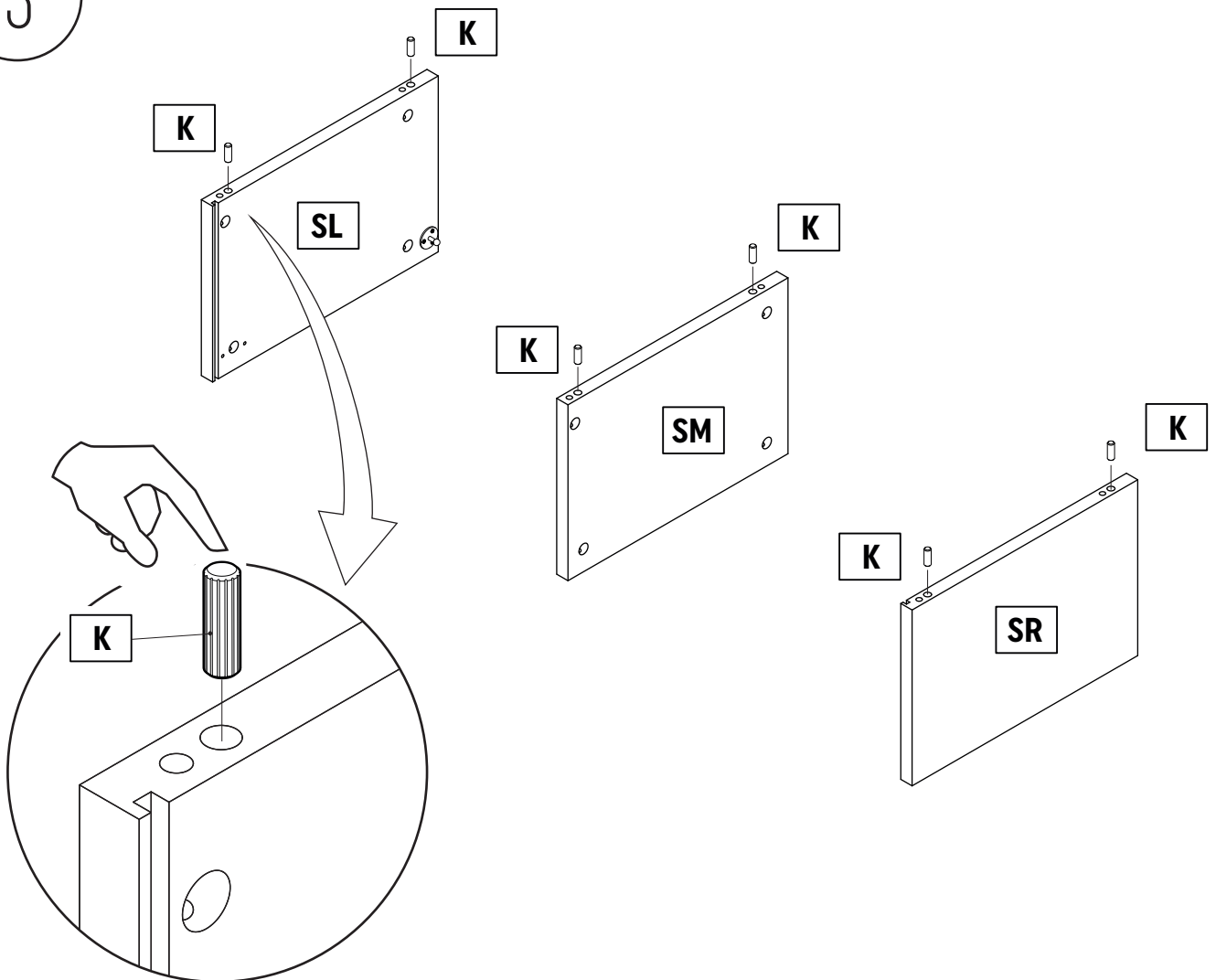

4

"C"

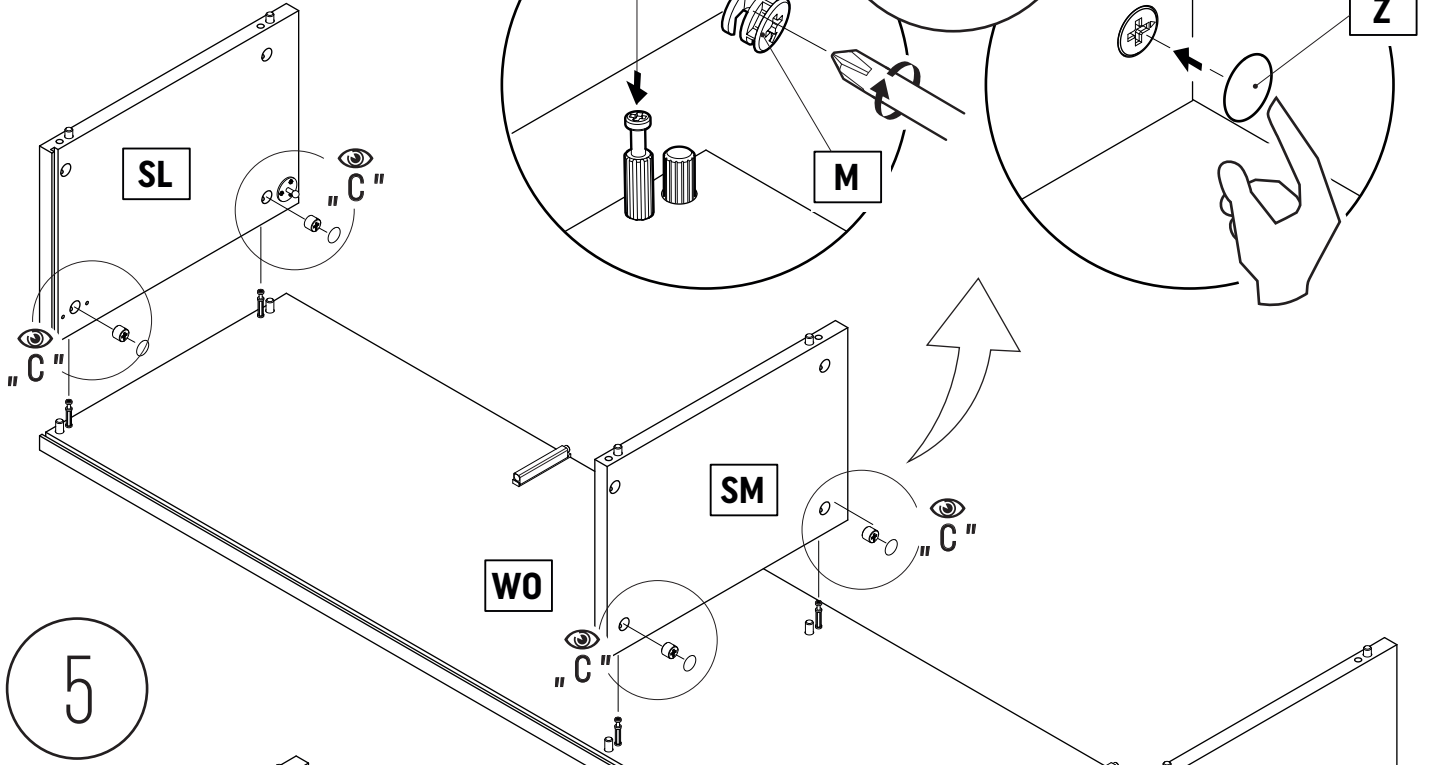
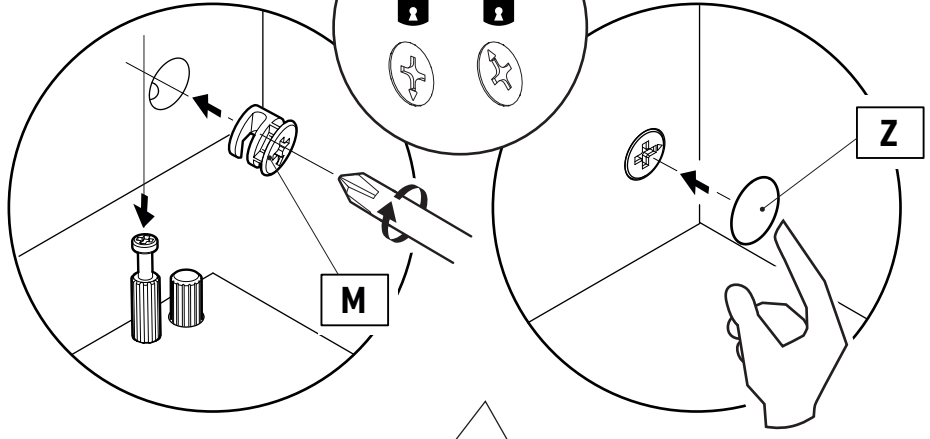
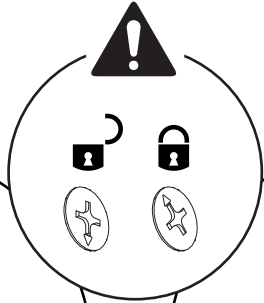

5

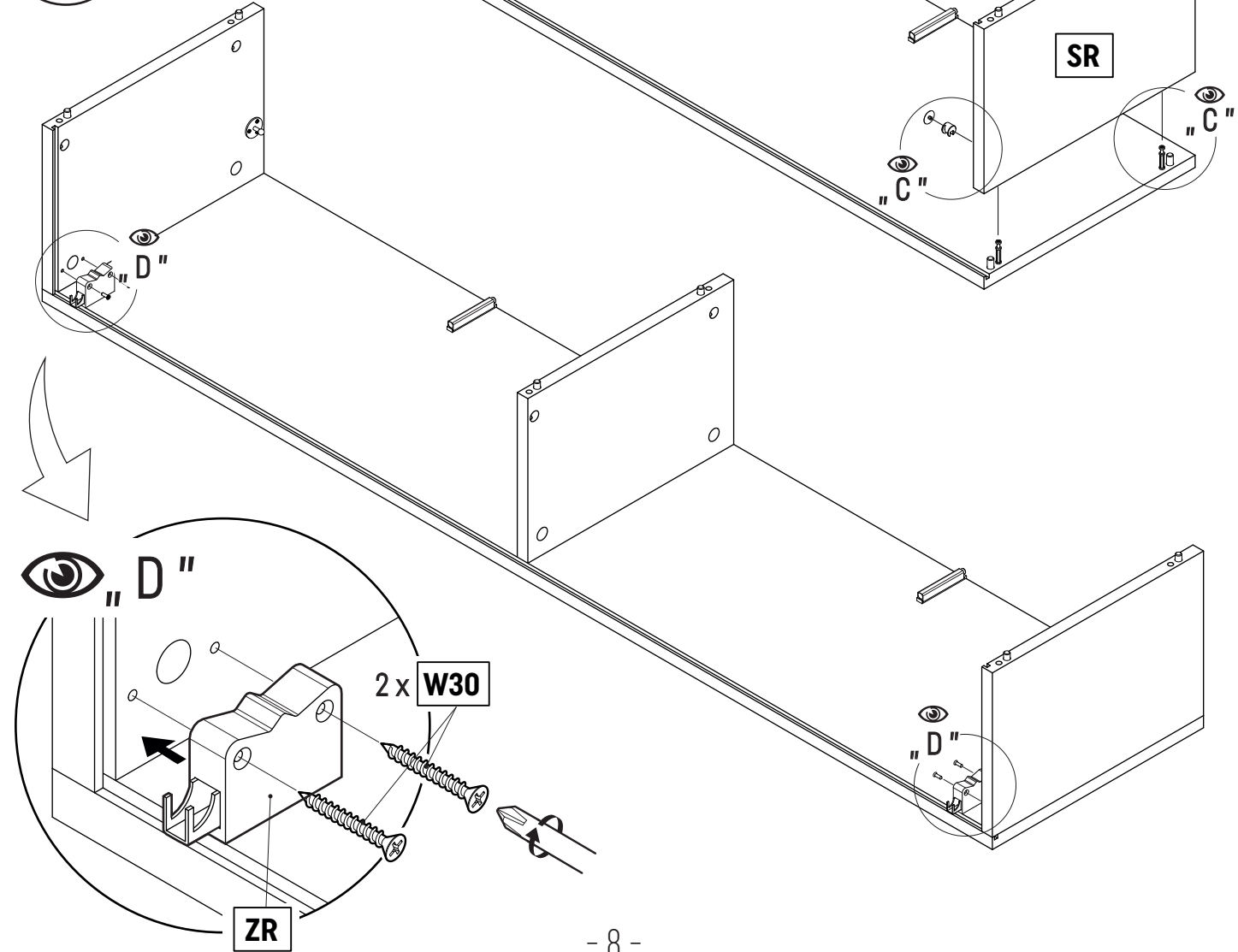

6

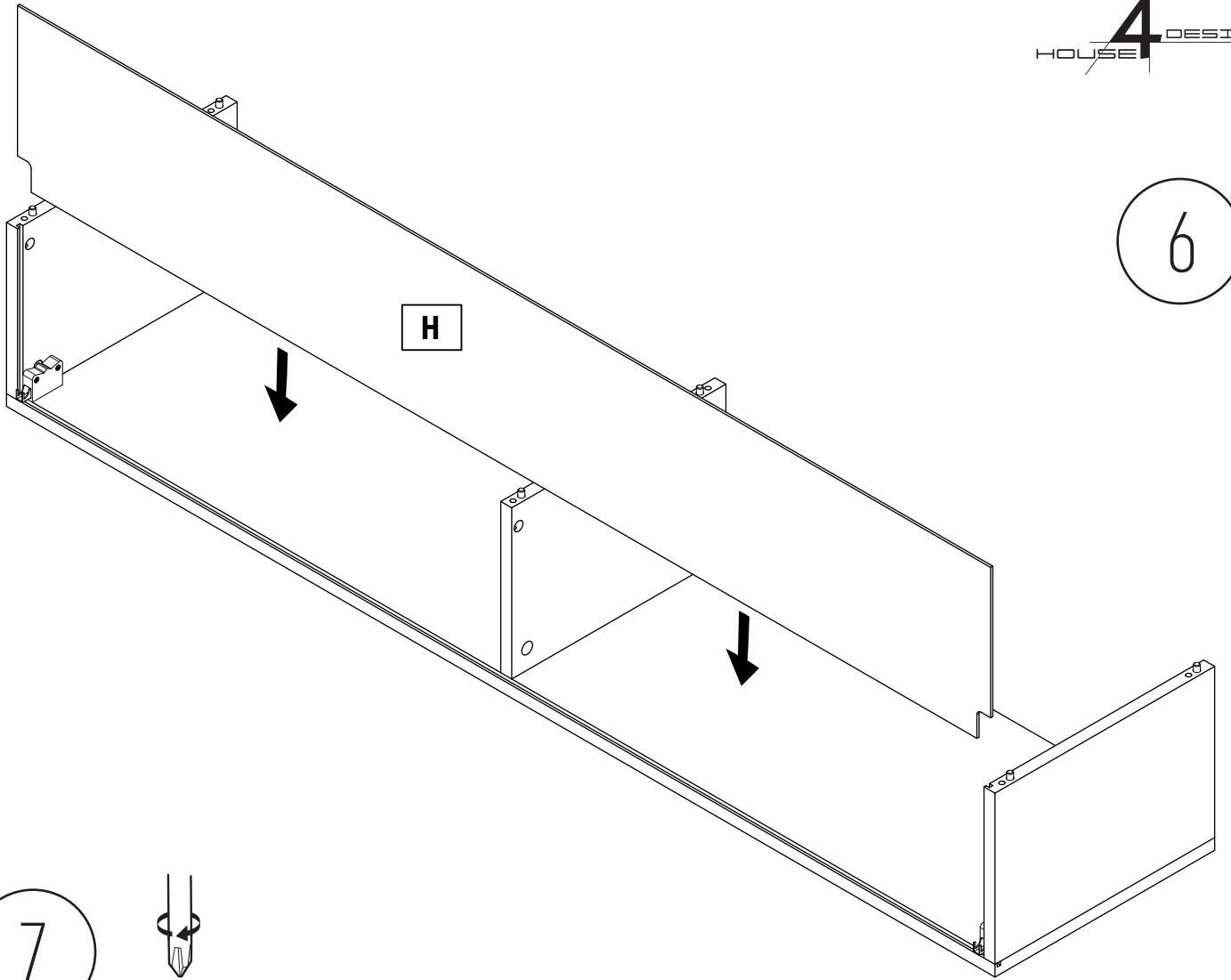

7

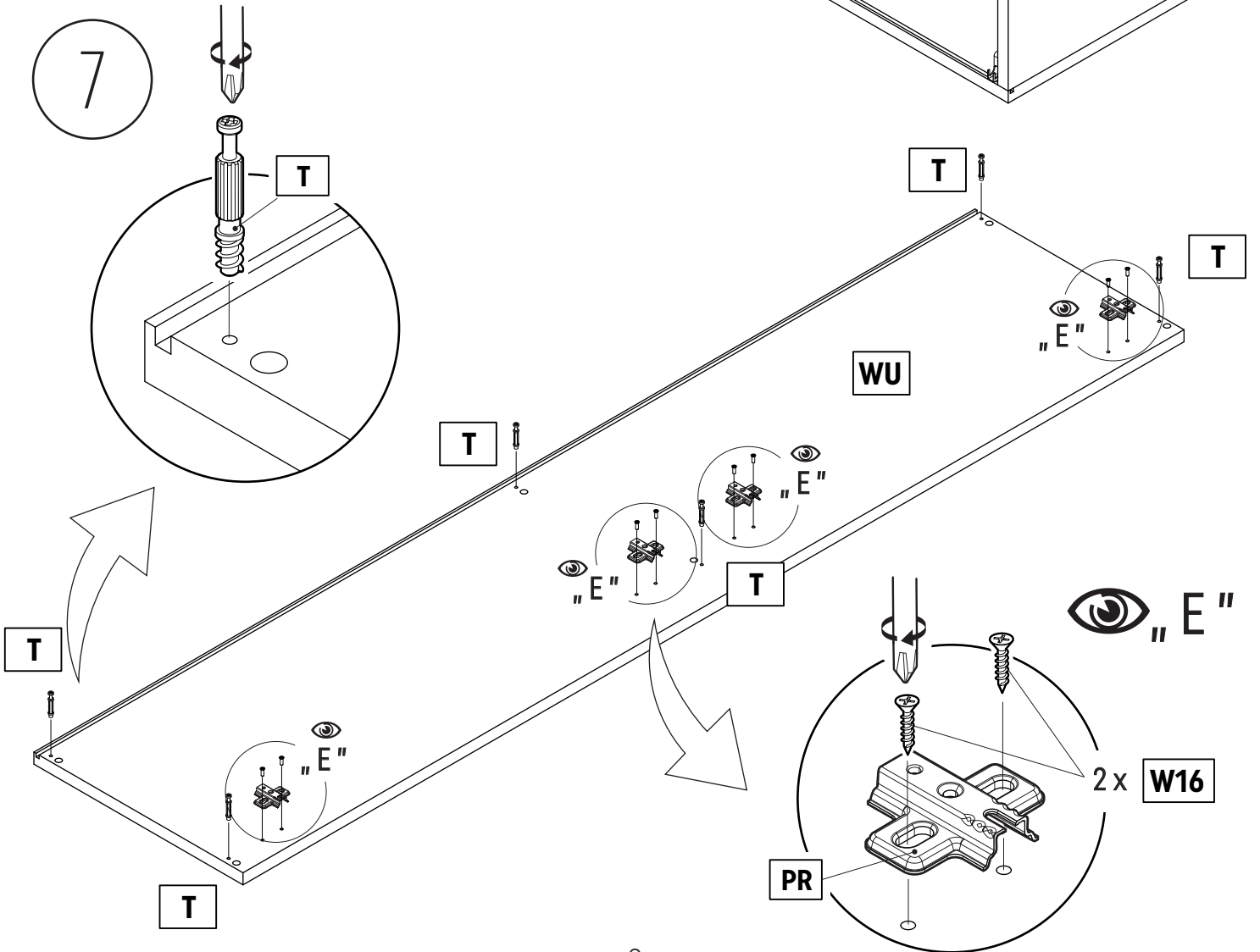

8

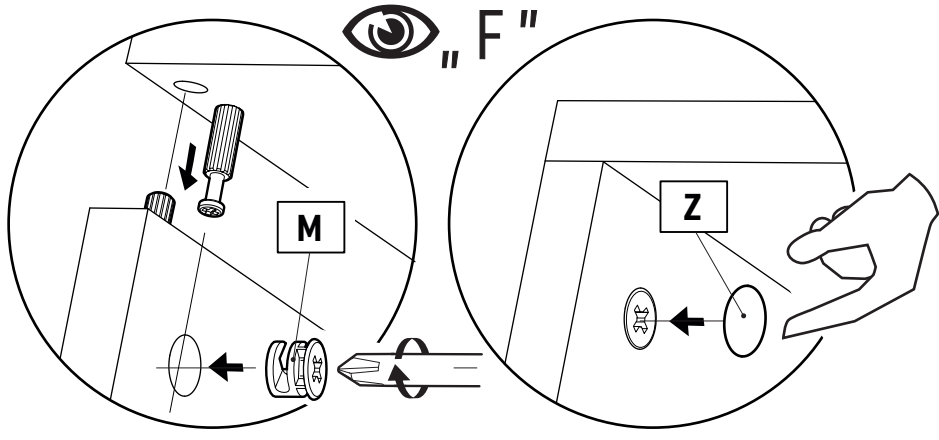
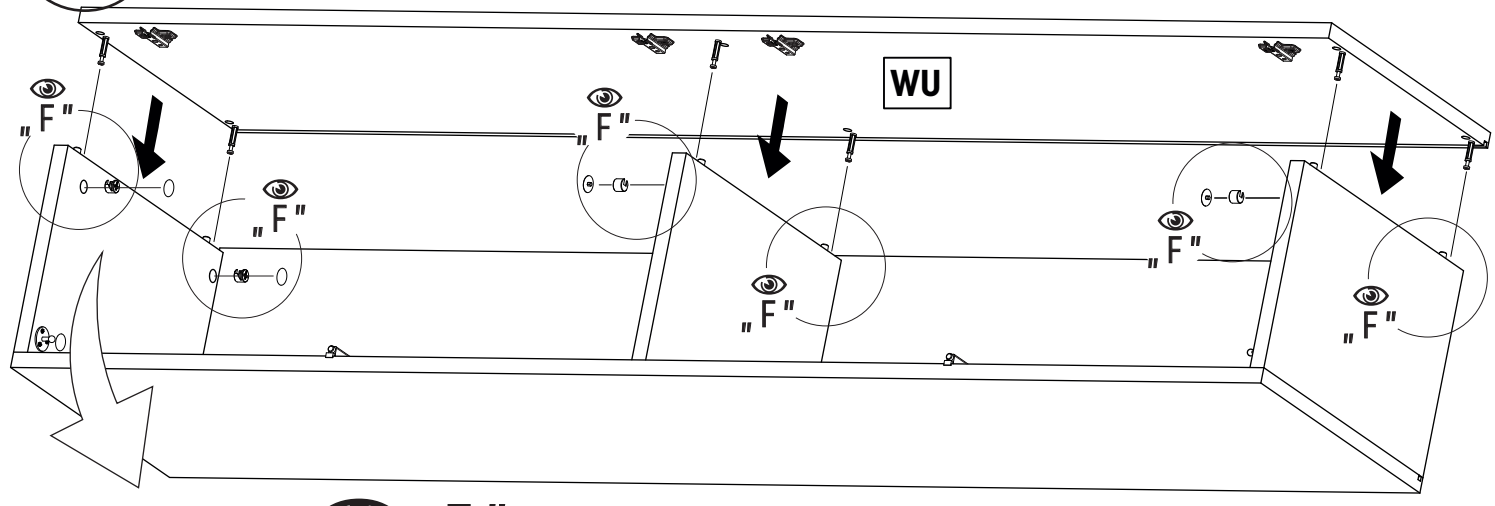

9

